

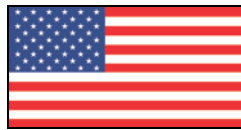

2018 206 United States Rule Set



Effective January 15, 2018
(Last updated 4/10/18)

The 206 engine platform was designed and engineered exclusively for racing. Each engine is hand-built in Milwaukee, Wisconsin using dedicated tooling and dies to provide a level of consistency unmatched in the industry today.

The 206 is intended to simplify racing, from hitting the track to the tech process needed to ensure a level playing field at the end of the day. In combination with Briggs & Stratton Racing's slide restriction system a complete racing ladder can be developed by simply changing a carburetor slide and/or by a slide and ignition change. With the base engine the basis for today's 'box stock' classifications, the 206 engine gives racer's and tracks the ability to have one engine, from start to finish.

All Briggs & Stratton (B&S) racing engines are manufactured solely for sanctioned racing only. B&S does not recommend the products referenced herein to be used for an application outside of sanctioned racing as serious injury or death could result.

This rule package has been prepared by Briggs & Stratton Racing and is intended to establish the sole basis for technical control of the 206 engine in competition. For all supplemental rules contact your sanctioning body.

**UNLESS THESE RULES STATE THAT YOU
CAN DO IT, YOU CANNOT DO IT.**

**EACH RACER IS SOLELY RESPONSIBLE TO MAINTAIN AND
CHECK ENGINE LEGALITY PER THIS PUBLISHED RULE SET.**

**This rule package covers all engine related technical specifications.
For all other regulations beyond the engine please refer or contact your
sanctioning body.**

CONTENTS

1.	Briggs & Stratton Racing Class Structure.....	3
2.	These Regulations Are the Only Regulations	4
2.5.	The 3 Core Rule Set Technical Inspection Principals:	4
3.	Briggs & Stratton 206 Product Availability	4
4.	General Rules	5
5.	Things That Are NOT Permitted.....	5-6
6.	Engine Sealing.....	6
7.	Technical Inspection Tools.....	6
8.	Engine Ignition Switch	6
9.	Engine Air Filter	6-7
10.	Engine Fuel	7
11.	Engine Oil	7
12.	Oil Breather.....	7
13.	Oil Catch Container	7
14.	Carburetor Overflow	7
15.	Fuel Pump.....	7-8
16.	Cooling Shrouds, Covers and Blower Housings.....	8
17.	Use of Helicoils	8
18.	Carburetor & Intake Manifold.....	8-10
19.	Cylinder Head.....	11
20.	Head Gasket.....	11
21.	Ports	11-12
22.	Valves	12
23.	Valve Springs	13
24.	Rocker Arms, Rocker Ball and Rocker Arm Studs.....	13
25.	Push Rods.....	13
26.	Engine Block	13-14
27.	Valve Lift	14
28.	Camshaft Profile Limits	15
29.	Flywheel	15
30.	Ignition System and Ignition Timing	15-16
31.	Crankcase.....	16
32.	Clutch.....	17
33.	Starter.....	17
34.	Exhaust Header	17
35.	Exhaust Silencer	17
36.	Exhaust Protection	18
37.	Torque Specification Guideline	18
38.	Technical Inspection Tools.....	18
39.	IMPORTANT ONLINE SUPPORT RESOURCES	18
40.	TOOL REFERENCE	19

1. Briggs & Stratton Racing Class Structure

The following class structure chart is intended as a reference only. Sanctioning bodies and organizations can alter the class structures to suit their driver licensing protocols.

Briggs & Stratton Racing Class Structure				
Class	Age	Weight (Pounds)	Engine Package	Technical Configuration
Briggs Kids Kart .310 Restrictor	5 thru 8 years---	190lbs	Junior 206 with carb lock	RLV pipe (#5507) .310 Slide (#555728) 4,100 RPM Rev Limiter
Novice	7 thru 10 years---	200lbs	206 with carb lock	RLV pipe (#5506 or 5507) 'Red' Slide (#555733)
Briggs Junior Light .520	8 thru 12 years---	225 lbs	206 with carb lock	RLV pipe (#5506 or 5507) 'Blue' Slide (555734)
Briggs & Stratton 206 Junior	11 thru 15 years--	300 lbs .570 Restrictor	206 with carb lock	RLV pipe (#5506 or 5507) 'Yellow' Slide (#555741)
Briggs & Stratton 206 Senior	15 years and up—	375 lbs	206	RLV pipe (#5506 or 5507) Stock Slide (#555590)
Briggs & Stratton 206 Masters	30 years and up—	405 lbs	206	RLV pipe (#5506 or 5507) Stock Slide (#555590)
Additional Legacy Slide Options Available: .285" – Black (#555728) .450" – Purple (#555735) .490" – Green (#555740)				

Cadet, Novice, Junior 1, Junior 2 and National Junior classifications require the installation of the locking cap Part #555726 on the carburetor slide cover. It is not permitted to run the classes without the specified slide and locking cap. The locking cap must be tightened. A seal can be utilized at the discretion of the organizer, or alternatively painted by the technical officials.

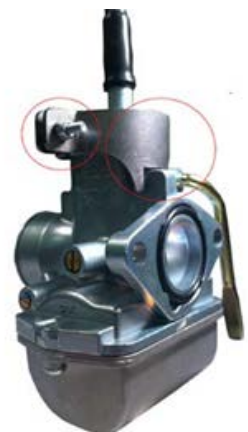

Optimization of the slide opening in Briggs & Stratton Cadet, Novice, Junior 1, Junior 2 and National Junior classes is permitted. The only allowable method of slide optimization is by removing material from the throttle cap area highlighted in RED. The use of multiple gaskets and/or machining of the slide is prohibited.



Slide opening must not exceed the appropriate 'no go' specification as per class regulations. For information on slide optimization see video section at www.BriggsRacing.com

CAUTION – The risk of pushing the limit on the slide opening is an unnecessary DQ. For every .010" of slide opening, due to the efficiency limitations of this engine, is less than .1 hp. Give yourself a buffer because it makes no measurable performance differences.

2. These Regulations Are the Only Regulations

- a. Only the B&S Racing Department in Milwaukee can make changes to the technical specifications herein.
- b. B&S dealers and their agents are not authorized to alter, verbally or otherwise, any technical specifications or competition rule herein.
- c. Should any B&S literature, catalogues, manuals, videos, etc. be different than these regulations, these regulations take precedence.
- d. Changes, corrections, addendums, etc. will be submitted to sanctioning bodies and posted at www.karting.com for republication and will become effective on a date specified.

2.5. The 3 Core Rule Set Technical Inspection Principals:

- a. Unless these rules state that you can do it, you cannot do it.
- b. Spirit and Intent (Syd White rule): Covered, stated, restated, or unstated any change or action with the sole intent to wrongfully create a performance advantage is grounds for disqualification.
- c. All parts are subject to comparison with a known stock part. This includes specified and mandated aftermarket parts. Example: RLV exhaust and silencer.

3. Briggs & Stratton 206 Product Availability

The 206 engine products and service parts are available only through the authorized Briggs & Stratton Racing dealers.

A list of authorized dealers can be found at www.karting.com

4. General Rules (updated 01/15/2018)

- a. The terms stock, original equipment, OEM, unaltered, etc., refer to Original Equipment supplied by Briggs & Stratton.
- b. Only the original equipment Briggs & Stratton 206 #124332-8201 or Junior 206 #124332-8202 engines are allowed in the classes recommended herein.
- c. All parts must be unaltered Briggs & Stratton 206 parts specifically made for this engine by Briggs & Stratton. No aftermarket parts to be used unless specified in these regulations.
- d. All parts are subject to comparison with a known stock part. This includes specified and mandated aftermarket parts. Example: RLV exhaust and Silencer.

e. A tech official may use additional means of measuring components to compare against a known stock part.

- f. The tech official, at their sole discretion, may at any time replace a competitor's sealed engine, carburetor, or head assembly with another sealed engine or known stock part. Failure to comply is grounds for disqualification.
- g. **IF** a competitor's part is replaced per 4f it must be drilled or reconfigured in a way that prohibits the reuse of that part.
- h. Briggs & Stratton 206 classes must have a serialized block. Exception: For early built engines without a block serial number the engine identification sticker must be in place and legible. If the sticker is illegible or missing the engine must be tagged with a suitable sticker or seal approved by the technical inspector.
- i. Standard organizational protest procedures can allow for short block inspection (seal removal) if a *new*, replacement short block, p/n 555715 is offered in replacement. Competitor short block to be forfeited to the series or club as terms of this procedure.

5. Things That Are NOT Permitted

- a. Tampering of the factory installed engine seals (2).
- b. Addition or subtraction of material in any form or matter.
 - a. Exception – Valve maintenance (valve job). Valve seats must remain with the factory specification of 30 and 45 degree angles only. Valve seats of additional angles and/or angles not comparable to the factory stock of 30 and 45 degrees are not permitted. Grinding of valve stem or excessive material removal prohibited.
 - b. Exception – Optimization of the slide opening in Briggs & Stratton Cadet, Novice, Junior 1, Junior 2 and ASN National Junior classes are permitted per section 1 guidelines.
- c. "Blueprinting" unless stated herein.
- d. Modification to or the machining of any parts in order to bring them to stated

minimum/maximum specification, (or for ANY reason).

- e. Machining or alteration of any kind to the engine or replacement parts unless specifically stated herein.
- f. Deburring, machining, honing, grinding, polishing, sanding, media blasting, etc.
- g. Sandblasting or glass-beading any interior engine surfaces.
- h. No device may be used that will impede, or appear to impede, airflow to the engine cooling system.

6. Engine Sealing

There are two custom, Homeland Security Tier III rated seals installed at the factory. Tampering of the seals is not permitted. Should the seals be tampered with, the engine is no longer eligible for competition. Should an engine require dismantling for any reason that requires breaking of the seals, contact Briggs & Stratton at: **Briggs & Stratton Racing – Email: Briggsracing@basco.com**



Seals can have either a black anodized or bare aluminum finish on both main body ends as shown.

7. Technical Inspection Tools

Briggs & Stratton have made available a number of tools for the convenience of technical checking of components when necessary. They are indicated throughout the rule thusly: **Tech Tool #**. See Section 38 for tool description. The tools are available from:

Sox Racing • 2223 Platt Springs Rd. • West Columbia, SC 29169 • (803) 791-7050

8. Engine Ignition Switch

The B&S ignition switch and wires must remain in stock location. It is not permitted to alter the OEM wiring.

9. Engine Air Filter (updated 01/15/2018)

The only air filter permitted is the Briggs & Stratton Green Air Filter Part #555729. No modification to the filter element is permitted.

A protective shield may be attached for wet-weather competition. It is not permitted for the protective shield to create any ram-air effect.



A racer MUST start each race with the air filter properly attached but will NOT be penalized if the air filter falls off during the race. If air filter falls off during a race, it is STILL subject to tech.

10. Engine Fuel **Recommendation** (updated 01/15/2018)

Premium Gasoline no greater than 94 octane sold at normal roadside fuel stations open to the public. The addition of fuel additives in any manner is not permitted. Fuel dispensing location may be specified in Event Supplementary Regulations. **Specific gravity and hydrometer testing are acceptable tests when used in accordance to sanctioning body guidelines.**

11. Engine Oil

High-quality synthetic oil within a 10W-20 range recommended. No oil additives are permitted.

Factory Recommendation- Briggs & Stratton 4T Synthetic Racing Oil is engineered exclusively for the rigors of high revving, air-cooled racing engines (available through both Briggs Racing and Amsoil dealers). The use of 'karting' or 'automotive' oils is not recommended as many are hydroscopic in nature, offer limited protection over time, and/or were engineered for pressure, not splash lube systems. The use of these oils can induce engine failure and/or accelerate wear.

Engine oil testing/verification procedure is per standard sanctioning body guidelines.

12. Oil Breather

Oil breather must vent to a catch container.

13. Oil Catch Container

An oil overflow catch system is mandatory. Overflow tube must run from the crankcase breather to a catch container. The catch-container must be vented to atmosphere.

14. Carburetor Overflow

Carburetor overflow must be vented to a catch container.

15. Fuel Pump

Only fuel pump, B&S part number 808656, is legal for competition. This fuel pump can be identified by the Briggs & Stratton diamond logo on the pump face. All other pumps are prohibited.

It is prohibited to pulse from the intake manifold.

Relocation of the fuel pump is legal as long as it is spaced to less than 3/4 inch off of the control plate, B&S #555699, in a similar location that is both safe and secure. Measurement is from the base of the control plate to the bottom of the fuel pump. Vertical mounting or mounting the fuel pump upside down is NOT allowed. The fuel pump must be pulsed from a pulse fitting mounted on the oil fill fitting located on the engine side cover. Aftermarket one-piece filler/pulse fittings such as shown on the right are permitted. The use of silicone sealant on the brass vent IS permitted and recommended. A fuel pump return line to the fuel tank is prohibited.



A fuel filter is not required but highly recommended to insure that dirt and contamination within your fuel system does not impact your carburetors performance.

The fuel filter itself is not a tech item but only one fuel filter is legal for use and it can only be located between the fuel tank and fuel pump inlet (not between the pump outlet and carburetor).

16. Cooling Shrouds, Covers and Blower Housings

All pieces of the engine cooling shroud/blower housing and control panel must be stock B&S and properly installed. Rewind housing and cooling shroud (air guard) must remain stock as painted from the factory.

Engine Shroud may be painted any color. Any bolt, with the exception of the head bolt, that is used to secure sheet metal shrouds and covers may be replaced with larger diameter bolts.

No taping or covering of the rewind shroud is permitted.

17. Use of Helicoils

It is permitted to use Helicoil thread inserts for shrouds, valve cover, oil drain, oil fill holes, blower housing, and exhaust pipe attachment studs on the head and lower brackets.

18. Carburetor & Intake Manifold (updated 01/15/2018)

The B&S stock carburetor part #555658 is the only carburetor permitted. 'Walbro', 'Briggs' diamond logo and/or #590890 etched in the body are additional visual indicators. **NO** alterations allowed unless stated below. All parts will be compared to a stock known B&S part for eligibility. This includes the nozzle, emulsion tube, jets, float, float needle and all other carb parts. It will be allowed however to adjust the float height by means of bending the small tab on the float arm.

A slight chamfer around the choke bore ID (air horn) may be present. 1.149" no go **Tech Tool A7**.

Slide must remain B&S stock unaltered. Slide cutaway to be measured on flat surface. .075 no go **Tech Tool A10**. **ALL intake manifold fasteners to remain factory stock. The use of studs, etc. are illegal.**

Idle pilot jet must remain completely stock and be clearly identified with its original etched or stamped '32' as shipped from B&S.

Main jet must also remain completely stock and be clearly identified with its original etching or stamped '95' as shipped from B&S.

B&S stock unaltered aluminum needle is required part number 555602 marked #BGB. Needle to be inspected using **Tech Tool A4**. Needle, when placed in tool A4, should not protrude through the other side. If needle protrudes through the block it is out of specification.



Throttle cable cap on the top of the carburetor must be properly installed and secured in the fully tight position.

Metal choke cover must remain in place but may be secured with silicone or epoxy sealer. Additional pin punching is allowed to tighten choke cover.

Air must only enter the engine from the natural air filter horn of the carburetor. Air entering through any other method is illegal.

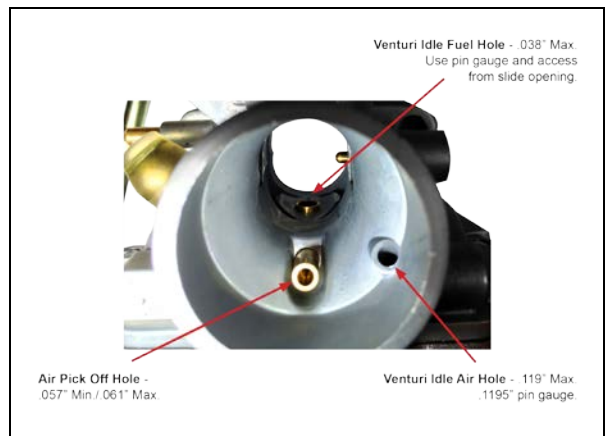
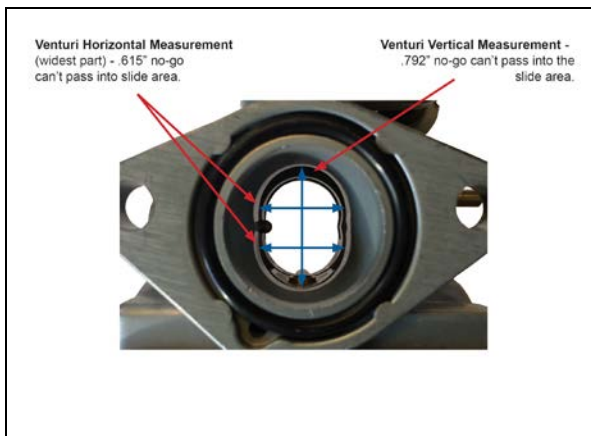
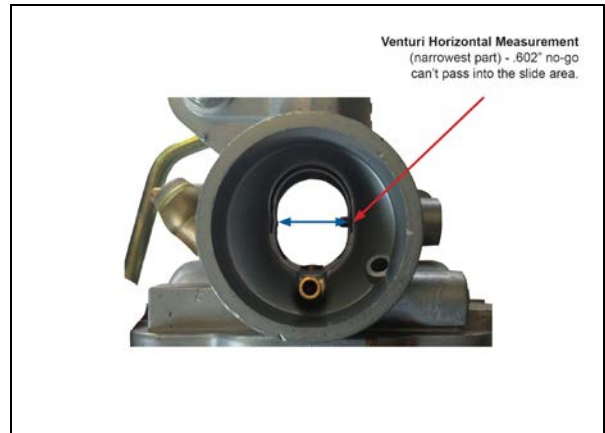
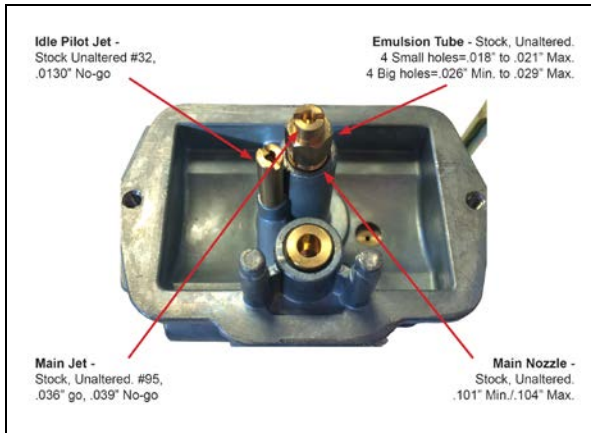

NOTE: Slide openings should be measured only with the Briggs & Stratton slide tool listed on the tool reference chart.

Technical Item	Description	Tech Tool
a. Needle Jet C-clip	Needle Jet C-clip must be properly installed but may be installed at any of the 5 factory settings on the needle jet.	
b. Throttle cable cap	Throttle cable cap on the top of the carburetor must be used and properly installed in tight position.	
c. Choke	Choke: OEM unaltered, but lever may be fastened open with a spring, rubber band, wire, etc.	
d. Idle pilot jet	Idle pilot jet – #32, hole size is .0130" no go.	
e. Idle circuit air hole	No drilling, reaming, elongating of the hole allowed. .119" max. diameter. A small chamfer at the outer edge, as compared to a stock part, can be present. The measurement of that chamfer is subject to sanctioning body guidelines.	.1195" Pin gauge
f. Main jet	Main jet – #95, hole size is .0380" 0.036 go, 0.039 no go	
g. Main nozzle and Emulsion tube	Main nozzle – OEM stock unaltered – hole size = .101 min and .104 max inches. No drilling, reaming, slotting or oblonging of hole. Emulsion tube – OEM stock unaltered 4 small holes = .018 min inches to .021 max inches 4 big holes = .026 min inches to .029 max inches.	
h. Venturi Measurement	Venturi Measurement: Vertical: .792 max inches.	A8
	Horizontal: .615 max inches at widest part	A8
	Horizontal: .602 max inches at narrowest part.	A20
i. Air pick off hole	Air pick off hole - .057 go .061 no go	A9
j. Throttle bore	Throttle bore – Must be as cast and bore max diameter = .874 inches.	A7
k. Venturi idle fuel hole	Venturi idle fuel hole = .038 inches max	
l. Air filter	Air filter: Only GREEN air filter, part # 555729 is allowed. Filter adapters are not allowed, filter must attach directly to carburetor air horn	
m. Carburetor overflow	Carburetor overflow: Must be vented to a catch container.	
n. O-Ring	O-Ring part number B&S part # 555601 is required and must be unaltered.	
o. Intake manifold	Intake manifold – max length = 1.740 inches min to 1.760 inches max	A12
	Intake manifold – bore diameter = .885 inches min to .905 inches max	A11
p. Choke Bore/Air Horn	1.149 no go	A7
q. Carb Slide Cutaway	.075 no go	A10
r. Widest part of Combustion Chamber	2.640	A30

19. Cylinder Head

- a. The ONLY head casting for the B&S 206 herein is the '**RT-1**', cast into the head just off the head gasket surface (towards the rear of the engine, PTO side). The overall head minimum thickness is 2.430".
- b. Cylinder head must be "as cast". Factory machining marks left on the head gasket surface **IS** a tech item.
- c. Hard carbon may be scraped from head before measuring.
- d. Depth of shallow area of combustion chamber must be .030 inch minimum. This measurement to be taken with a depth gage on both the combustion side and spark plug side of cylinder head.
- e. Depth of the combustion chamber is .341 inch minimum.
- f. Inspect retainers for alterations that would increase valve spring pressure - .055 to .075 maximum flange thickness. Both intake and exhaust must have OE stock B&S valve keepers.
- g. Unaltered B&S part #555552 (exhaust) and #555551 (intake) can be checked for appearance, weight, and dimensions. No machining, polishing, easing, or alterations of any kind allowed. Valve surface must remain as factory, with one single 45 degree face. No other additional angles allowed on any part of the valve. **Tech Tool A22**.
- h. Valve Guides: Replacement of valve guides with B&S part #555645 only is allowed. Maximum depth from the head gasket surface to the intake valve guide is 1.255".
- i. Briggs & Stratton heat disperser, p/n 555690 can be installed in the exhaust bolt boss per factory instructions.

20. Head Gasket (updated 4/10/18)

- a. Unaltered B&S part #555723 is the only head gasket allowed.
- b. Minimum thickness allowed is .047". Measurement must be performed using a micrometer. Readings are taken from inside the cylinder hole of the gasket closest to the combustion chamber (see diagram). Four measurements **are to be taken in the four defined quadrants** with 3 meeting the minimum thickness of .047".

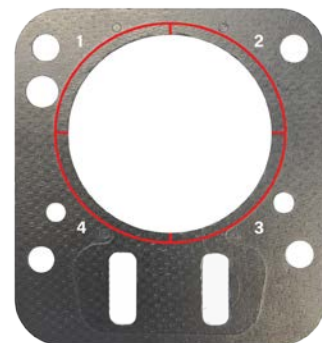

21. Ports

- a. No de-burring, machining, honing, grinding, polishing, sanding, media blasting, etc.
- b. The transition from intake bowl to port must have factory defined machining burr at this junction.

No addition or subtraction of material in any form or matter.

No alterations of any kind may be made to the intake or exhaust ports.

- c. Intake Port: Maximum diameter measurement = .918 inches max. **Tech Tool A6.**
- d. Exhaust Port AS CAST. Exhaust Outlet -.980 – **Tech Tool A6.**
- e. Valve Seats. Intake and exhaust: Must remain factory specification with one 30 and one 45 degree angle only. Valve seats of additional angles and/or angles not comparable to the factory stock are not permitted.
- f. Valve maintenance permitted (valve job). Valve seats must remain with the factory specification of 30 and 45 degree angles only. Valve seats of additional angles and/or excessive material removed when compared to the factory stock is prohibited.
- g. Intake valve seat diameter inside = maximum .972 inches. **Tech Tool A2.**
- h. Intake port pocket bowl (area just below valve seat) = .952 no go **Tech Tool A2**
- i. Exhaust valve seat diameter inside = maximum .850 inches. **Tech Tool A1.**

22. Valves

a. Intake valve

Minimum Weight of Valve	27.8 grams
Diameter of valve stem	.246 to .247 inches
Diameter of valve head	1.055 to 1.065 inches Tech Tool A17
Diameter of valve seat	.972 inches ID maximum
Valve length	Minimum 3.3655 inches
Height from angle of valve face to top of the valve	.057 inches minimum Tech Tool A26

b. Exhaust valve

Minimum Weight of Valve	27.2 grams
Diameter of valve stem	.246 to .247 inches
Diameter of valve head	.935 to .945 inches Tech Tool A18
Diameter of valve seat	.850 inches ID maximum
Valve length	Minimum 3.3655 inches
Height from angle of valve face to top of the valve	.060 inches minimum Tech Tool A27

23. Valve Springs

- a. Valve Springs are single coil stock, unaltered B&S part #26826. Must be identical in appearance to factory part and have 4.00 to 4.75 coils in stack.
- b. Spring Wire Diameter: .103 to .107 inches
- c. Valve spring length: .940 max inches **Tech Tool A15**
- d. Inside diameter: .615 to .635 inches

24. Rocker Arms, Rocker Ball and Rocker Arm Studs

- a. Rocker arm must be stock B&S part #555711 (US) or #797443 (METRIC) and may not be altered in any way.
- b. Rocker studs must be stock, unaltered B&S part #694544 US (1/4-28 thread) or #797441 Metric (M8x1.00 thread) and in stock location.
Rocker arm #555711 (US) must be used with rocker stud #694544 (US).
Rocker arm #797443 (Metric) must be used with rocker stud #797441 (Metric).
- c. Rocker Ball must B&S stock. Diameter .590 inch min. to .610 inch maximum. **Tech Tool A16.**
- d. Rocker arm mounting positions may not be altered in any manner. No heli-coiling of mounting holes. No bending of studs.
- e. Rocker arm stud plate must be bolted to the head with one, OEM stock B&S gasket only – no alterations. Maximum thickness of gasket is .060 inches. Rocker plate to head fastener holes must remain stock, .289" max.
- f. Rocker arm – overall length 2.820 inch minimum. Can be checked with a pair of dial calipers.

25. Push Rods (updated 01/15/2018)

- a. Push rods must be unaltered stock B&S part #555531.
- b. Push rod length 5.638 minimum inches to 5.658 maximum inches. **Tech Tool A5.**
- c. Push rod diameter .183 minimum inches to .190 maximum inches. Push rod length 5.638 minimum inches to 5.658 maximum inches. **Tech Tool A5.**
- d. Push rod diameter to be checked 3 points along the length and must pass two planes on each 360 degrees of rotation.

26. Engine Block

- a. Engine block must be unaltered "as cast" B&S factory machined condition. There must be no addition or subtractions of metal or any substance to the inside or outside of the cylinder block.

- b. Both (2) B&S engine seals must be present with both the fastener and seal in "as shipped" from the factory location and condition. Any defined tampering with the fasteners or damage to the wire/seal itself (example: delaminated hologram) are grounds for disqualification.

Take proper care of your seals to ensure their integrity. It is recommended that you wrap your seals (using a plastic bag, etc.) to prevent exposure to harsh solvents such as carb cleaner, etc...

- c. Deck gasket surface finish is not a tech item. Piston pop up can be .005 inches maximum. Piston pop-up to be checked with flat bar in center of piston parallel to piston pin and then again checked 90 degrees to piston pin.

Tech Tool A25.

Angle milling or peak decking is not allowed.

- d. Carbon build-up can be removed before pop-up is measured as long as material is not removed from the piston. Exception – Competitors can deburr the manufacturing part number/marks IF needed as long as:
- Removal does not extend beyond the defined script area.
 - De-burring does not extend below the original piston surface area.
 - The original part numbers and script are still clearly visible.
- e. Cylinder bore will not be bored oversize
- f. Cylinder bore will not be re-sleeved.
- g. Cylinder bore position is not be moved or angled in any manner.
- h. Cylinder bore dimension: - Briggs & Stratton stock bore is 2.690". Allowance for wear is permitted up to 2.693" maximum for entire length, top to bottom.
- i. Maximum stroke is 2.204". Push piston down to take up rod play. Check stroke on BDC to TDC. **Tech Tool A21.**

27. Valve Lift

- a. Maximum valve lift is checked from the top of the valve spring retainer. Valves must be adjusted to zero clearance.
- b. Valve Lift: Camshaft check is taken at the valve spring retainers. With the lash set at zero, the movement of the valve spring retainers may not exceed the following: Intake and exhaust: .255 inches maximum.

28. Camshaft Profile Limits (measured at the push rod)

Push gently down on dial indicator stem to ensure that there is no lash when push rods are going down.

NOTE: Due to the extended life of the engine, a single ppoint on each lobe can be off by a maximum of 2 degrees without issue, the exception being on the .006" check, both intake and exhaust.

Intake lift		Exhaust lift	
0.006	59 TO 51 BTDC	0.006	101 TO 93 BBDC
0.020	16 TO 12 BTDC	0.020	59 TO 55 BBDC
0.050	.5 TO 4.5 ATDC	0.050	43 TO 39 BBDC
0.100	17 TO 21 ATDC	0.100	26 TO 22 BBDC
0.150	33.5 TO 37.5	0.150	9 TO 5 BBDC
0.175	43 TO 47 ATDC	0.175	1 TO 5 ABDC
0.200	54 TO 58 ATDC	0.200	11.5 TO 15.5
0.225	68 TO 72 ATDC	0.225	25 TO 29 ABDC
MAX LIFT	0.257	MAX LIFT	0.259
MIN LIFT	0.252	MIN LIFT	0.252

Intake lift		Exhaust lift	
0.225	38 to 34 BBDC	0.225	76 TO 72 BTDC
0.200	24.5 TO 20.5	0.200	62.5 TO 58.5
0.175	14 TO 10 BBDC	0.175	52 TO 48 BTDC
0.150	4.5 TO .5 BBDC	0.150	42 TO 38 BTDC
0.100	12 TO 16 ABDC	0.100	25.5 TO 21.5
0.050	29 TO 33 ABDC	0.050	8.5 TO 4.5 BTDC
0.020	45.5 TO 49.5	0.020	8 TO 12 ATDC
0.006	83 TO 91 ABDC	0.006	47 TO 55 ATDC

29. Flywheel

- No modifications are allowed to the flywheel.
- The minimum weight of the flywheel, fins and attachment bolts is 4 pounds 1 ounce.
- Stock B&S part #555683 only. No machining, glass beading, sand blasting, painting or coating of flywheel is allowed.
- A flywheel fan, B&S part #692592, with broken fins must be replaced.
- Stock, unaltered B&S flywheel key with the B&S logo is required. Width of the key allowed is .1825"-.1875". No offset keyways allowed.

30. Ignition System (updated 01/15/18)

- Unaltered B&S stock ignition** part #555718 is mandatory. Only "GREEN" ignition module allowed. Maximum RPM: 6,150.

Exception – Cadet Junior 206 class requires the use of unaltered B&S stock ignition part #555725 (BLACK in color). Maximum RPM: 4,150.

- Coil or its position**, other than air gap may not be altered in any way. Coil

mounting bolts must be stock and cannot be altered in any way to advance or retard timing. Attachment bolts and/or bolt holes may not be altered.

- c. **Spark plug:** Only the B&S unaltered factory spark plug part number #555737 -Champion RC12YC is permitted. Spark plug must have the "Champion" and Briggs & Stratton logo as well as the RC12YC identification on the insulator. Sealing washer must be in place, unmodified as from the factory.

Temperature thermocouple permitted as long as sealing washer and/or air guard are not modified.

- d. **Spark plug connector:** Only the OEM B&S part #555714 is permitted.

- e. **Magneto air gap** is non-tech (recommended clearance of .016")

- f. **Static check for timing:**

- Install a degree wheel using a positive stop method.

- With the left edge of the first magnet aligned with the start of the lead leg of the ignition (refer to photo), the engine must not exceed 26 degrees with air gap set at .016". Timing checked in the direction the engine operates.

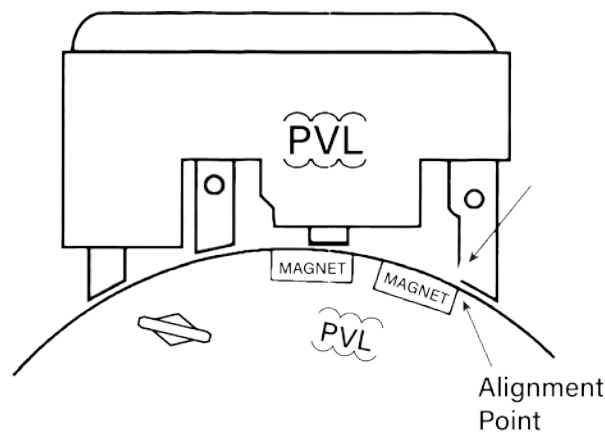

31. Crankcase

Crankcase and cover must be Briggs & Stratton stock, unaltered, "as cast in factory" condition. No alterations or subtractions of metal or any other substance to crankcase cover.

32. Clutch (updated 01/15/2018)

- a. Novice class must run the supplied Max-Torque clutch, part #555727. No alteration to the clutch is allowed, except springs, driver (when applicable), driver conversion and clutch key are non-tech.
- b. Junior 1, Junior 2, Senior, and Masters Classes can run any rim centrifugal clutch with a maximum of 9 springs and 6 shoes. Clutch must be used as shipped from the ORIGINAL manufacturer. Mixing of parts between clutch lines or manufactures or removing parts (ie. Grease guard, etc.) is ILLEGAL. No alteration to clutch allowed except springs, driver, driver

conversion, clutch key, and crankshaft fastener kit, which are non-tech.
Clutch coolers are not allowed.

- c. Clutch drums must be stamped single-piece steel only. **Clutch hubs must be single-piece steel, other alloys not allowed.**
- d. Clutch claim rule - Per standard sanctioning body guidelines, claiming can be implemented, Maximum of \$160.00.

33. Starter

Recoil starter, B&S part #695287, must be retained, as produced and intact.
Starter maybe rotated.

34. Exhaust Header

- a. Header must be RLV Model 5507 or 5506 for all classes.
- b. Header length:
 - a. 5507 will measure 18.75" +/- .25" along the short side using a 0.250" wide tape measure.
 - b. 5506 will measure 17.50" +/- .25" along the short side using a 0.250" wide tape measure.
- c. Gasket and/or silicone are allowed to seal header to head. (One gasket maximum)
- d. Studs or bolts are permitted to fasten header to head. Bolts or nuts must be safety wired.
- e. Helicoiling of the exhaust is allowed.
- f. Supplied header support brace is mandatory. The addition of a mechanical support bracket (no welding involved) is allowed provided that there are no alterations to the shape or dimensions of the exhaust configuration.
- g. Any modification for or use of an O2, EGT, CO2 sensor is **prohibited**.

35. Exhaust Silencer

Silencer must be RLV B91XL (part number 4104) with round baffle holes only. Safety wiring of the silencer to header is mandatory. All 4 baffles must remain unaltered and the hole size can be verified using a no-go pin of .1285. Exhaust gases may only exit through the muffler baffles. Muffler must be mounted on the header in a way that does not allow exhaust to leak at this joint. The exception, if a header becomes loose (header bolts loosen) during a race but remains mounted to the head this not grounds for disqualification.



36. Exhaust Protection

The header must be completely wrapped (360 degrees) with a non-asbestos,

approved insulation material or sleeve starting approx. 3 inches from the exhaust flange but MUST extend to where the stock supplied RVL support (welded or clamped) meets the header.

37. Technical Inspection Tools

A complete video of the 206 inspection tools and process is available at www.BriggsRacing.com.

38. IMPORTANT online support resources

Please refer to www.Briggsracing.com for a host of resources. Due to the sealed nature of this engine we highly recommend reading and viewing important documents and videos to insure a great racing experience.













Located online:

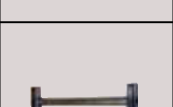



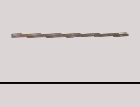
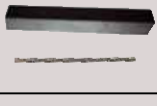





- a. 206 Engine tips and guide supplement – A must to print out and read BEFORE installing your engine!
- b. Carburetor tuning guide – Understand your carburetor to get the most out of your 206.
- c. Videos:
 - a. Proper clutch installation – Properly installing your clutch will prevent the possibility of crankshaft damage.
 - b. Setting the float height – A simple video highlighting a necessary technique to insure a properly tuned carburetor.
 - c. Setting, measuring, and optimizing your junior slide restrictor.

**UNLESS THESE RULES STATE THAT YOU
CAN DO IT, YOU CANNOT DO IT.**

**EACH RACER IS SOLELY RESPONSIBLE TO MAINTAIN AND
CHECK ENGINE LEGALITY PER THIS PUBLISHED RULE SET.**

TOOL REFERENCE

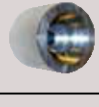
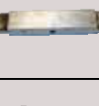
	Exhaust Valve Seat Diameter Max: 0.850 Tool: A1
	Intake Valve Seat Diameter Max: 0.972 Tool: A2
	Intake Port Pocket Bowl Gauge Max: 0.952
	Needle Jet Diameter Max: 0.070 Tool: A4
	Push Rods Length Max: 5.658 Min: 5.638 Tool: A5
	Intake Inlet Diameter Max: 0.918 Tool: A6
	Exhaust Outlet Diameter Max: 0.980 Tool: A6
	Throttle Bore Diameter Max: 0.874 Tool: A7
	Choke Bore Diameter Max: 1.149 Tool: A7
	Venturi Measurement Vertical Max: 0.792 Tool: A8
	Horizontal Max: 0.615
	Air Pick Off Hole Diameter Max: 0.061 Min: 0.057 Tool: A9
	No go Go
	Slide Cutaway Max: .075 Tool: A10
	No go
	Intake Manifold Diameter Max: 0.905 Min: 0.885 Tool: A11
	Intake Manifold Length Max: 1.760 Min: 1.740 Tool: A12
	Rocker Arm Length Min: 2.865 Tool: A13

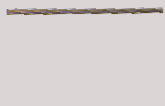
	Valve Spring Length Max: 0.930 Tool: A15
	Rocker Ball Length Max: 0.610 Min: 0.590 Tool: A16
	Intake Valve Head Diameter Max: 1.065 Min: 1.055 Tool: A17
	Exhaust Valve Head Diameter Max: 0.935 Min: 0.945 Tool: A18
	Venturi Measurement Horizontal Min: 0.602 Tool: A20
	Stroke Length Max: 2.204 Tool: A21
	Valve Angle Angle Max: 45° Min: 45° Tool: A22
	Piston Pop Out Length Max: 0.005 Tool: A25
	Intake Valve - Height from angle of valve face to top of the valve Length Min: 0.057 Tool: A26
	Exhaust Valve - Height from angle of valve face to top of the valve Length Min: 0.060 Tool: A27
	Width of Widest Part of Combustion Chamber Length Max: 2.640 Tool: A30
	Slide Tool ASN Canada FIA Briggs & Stratton National Class Structure 206 Club Class Options Class Max. Slide Opening Class Max. Slide Opening Junior 5/16" Yellow Cadet .310" Black Novice: .342" Purple Junior I .490" Green
	Jetting/Main Nozzle/Emulsion Tube Pin Gauges Idle Max: 0.0130 No go Main Max: 0.039 Min: 0.036 No go Go
	Emulsion Tube 4 Small Holes Max: 0.021 4 Big Holes Max: 0.029 Main Nozzle Max: 0.104